

# POL-200-TS

ANALOGUE LOOP DIAGNOSTIC TOOL

## Safety Information



**Severe damage** Please, before connecting any external cable, make sure the loop cable has been disconnected from the panel loop terminals and the tool is completely powered down.

Check for the right terminal connections and make sure there is no external voltage between the cables to be connected.



The battery life lasts maximum 3 years, so please check the year of manufacture!  
Operating at extreme temperatures will significantly affect the battery cycle life.

Danger of explosion in case of inappropriate battery replacement! Batteries must be disposed of according to the laws in force.

**Caution** In case of damage the warranty is limited if the operating and installation instructions are not followed. The company is not liable for any subsequent or accidental damages. These installation instructions must be read thoroughly before starting using the tool.

## Symbols

The following information is given to ensure personal safety and to prevent damage to the product described in this manual and to the equipment connected to it.

The safety information and warnings for the prevention of risks that can endanger the life and health of the users and the maintenance personnel and damage the equipment itself are marked by the following pictograms. In this manual, these pictograms have the following meanings:



**Warning** - Indicates risks for operators and/or machines. Any non-compliance will create risks for operators and/or machines.



**Note** - Important information on a topic or a procedure.

## Disposal



In accordance with Directive 2002/96/EG (WEEE), the electrical and electronic equipment, after being dismantled, must be returned to the manufacturer for proper disposal.

## Contents

Page

1	EQUIPMENT DESCRIPTION .....	4
1.1	Technical features .....	6
1.2	EC conformity .....	7
2	PACKAGING CONTENTS .....	8
3	EQUIPMENT USE .....	9
3.1	Battery charge .....	9
3.2	Connection .....	9
3.3	Main menu .....	11
3.4	Set language .....	11
3.5	Configuration .....	12
3.6	Multimeter .....	13
3.7	Loop .....	14
3.8	Sample .....	17
3.9	Map .....	17
3.10	Event recording .....	18
4	BATTERY REPLACEMENT .....	20
5	TROUBLESHOOTING .....	21

# 1. Equipment description

POL-200-TS is a device with a colour touch screen display. It is used for the preliminary check of the loop device installation compatible with Notifier control units.

POL-200-TS can recognize all the loop devices with CLIP/ADVANCED protocols from Notifier, with additional multimeter and oscilloscope functions. POL-200-TS makes the initial wiring test quick and easy. It also allows exporting a file to the PK-8200 software, which contains all the information on the types of devices detected.

Its use is extremely simple, thanks to a user-friendly interface and to the one-touch functions: it can even be used while wearing gloves.

The mapping function, using the loop isolators, allows the loop cabling topology to be checked. The screen can be used to read the manufacturing date and detailed information about the sensors, inputs and outputs or to identify the equipment status or even to detect internal equipment faults.

The log function generates a file with the status and data of each loop device. It allows an accurate control of the system operation by checking the loop devices to anticipate and record equipment maintenance tasks in critical situations.

The saved files can be easily downloaded via USB, without the need of special software. This makes it possible to retrieve and send the saved files for reviewing, checking and configuring the system.

The device and the log file include the serial number and the date of manufacture (month/year) of each device. The multimeter allows validating the wiring and identifying any connection problems. The oscilloscope function is very useful for identifying any electrical noise.

The six internal, 2500mA NiMH, rechargeable batteries provide the installer with sufficient capacity, up to 6 hours depending on the loop load.



POL-200-TS is designed to be used only by trained personnel who can interpret the instructions given.



Please note that POL-200-TS is a device designed to help you check the quality of the line and signal in your installation. POL-200-TS is not a fire protection equipment, it only provides qualified technicians with the necessary supporting information for the identification and solution of faults.

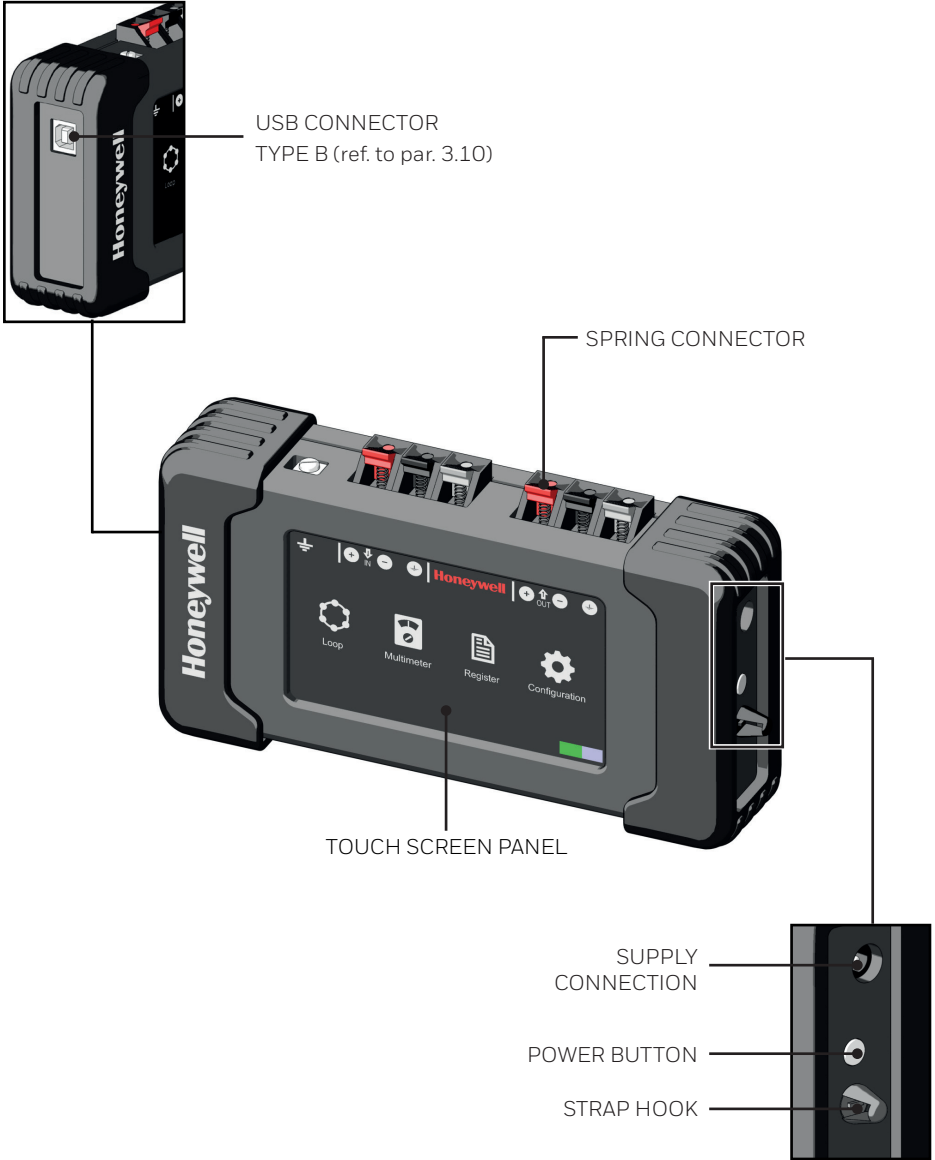

## 1.1 Technical features

Power supply	12 V charger (included)
Autonomy	>6 h with batteries charged to 100%
Batteries	6x AA 1.2V NiMH 2500mAh. Quick charge in 1h
Screen	4.2" TFT 480 x 263 pixels (98x56mm) with 66,000 colours
Keypad	Dynamic capacitive touchpad
Dimensions	97 mm (h) x 177 mm (w) x 44 mm (d) (including rubber case)
Colour	Black box with rubber protection in grey
Weight	550g (including batteries)
Operating and storage temperatures	Charge: 0°C to 40°C
	Operation: 0°C to 50°C
	Storage: -20°C to 30°C
	Humidity: 65 ± 20%

POL-200-TS has an even power-off that can discharge the batteries if it is not used for an extended period of time.



If the unit is not used for a long period, we recommend charging the batteries.



**Autonomy.** The battery lifetime will depend on the output (sounder, flash, and strobe) activation. If the batteries are fully charged and the installer is using the auto learn function, the unit will provide up to 6 hours of autonomy. When the unit is switched off, the current is very low, below 250µA, so the batteries will remain charged for days. In any case, it is advisable to fully charge the unit before visiting the site.

## 1.2 EC conformity

This document is a declaration that the products listed below conform to the essential protection requirements of the following European Directives:

- RoHS - Restrictions on the Use of Certain Hazardous Substances in Electrical and Electronic Equipment
- Equipment Directive 2011/65/EU
- Compliance with RoHS 2 - Product does not contain any hazardous substances above the limits designated in the RoHS Directive. Product falls within Category 9 - Monitoring and Control Instruments
- The EMC Directive 2014/30/EU, by the application of the following EMC Standards:
  - EN 61000-6-3:2007 +A1: 2011 (Emissions)
  - Electromagnetic compatibility (EMC) Generic emission standard for residential, commercial and light industrial environments.
  - EN 50130-4: 2011 +A1: 2014 (Immunity)
  - EMC Product family standard: Immunity requirements for components of fire, intruder and social alarm systems

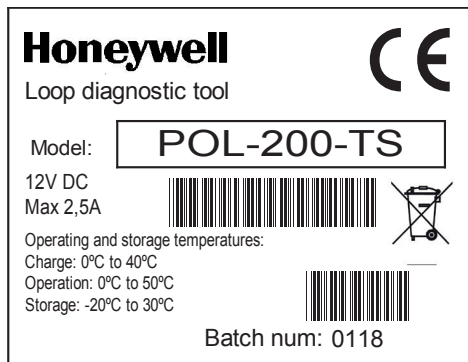

## 2. Packaging contents

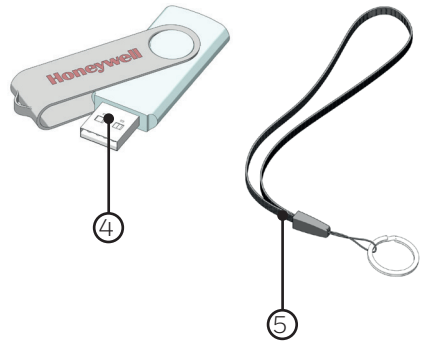
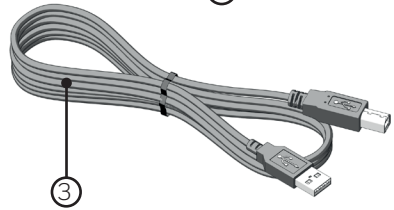
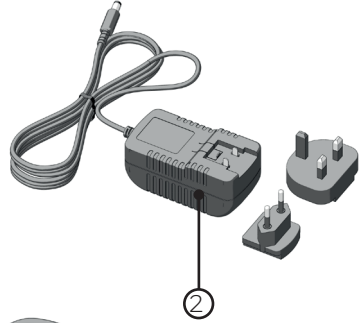
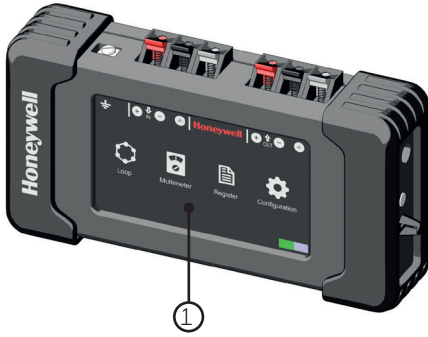

- 1 - POL-200-TS
- 2 - CHARGER
- 3 - USB CABLE
- 4 - USB KEY (user manual, device default files)
- 5 - STRAP



## 3. Equipment use

### 3.1 Battery charge

**i** Use only the original charger provided with the device. Do not charge the appliance at temperatures lower than 0°C or higher than 40°C. Using a universal charger will automatically invalidate the guarantee.

**Before you use the device for the first time, you must charge the battery completely.**

Put the proper adapter on the feeder, according to the country of use, then plug the battery charger into a socket and insert its end into the seat on the right side of the device. When the device is on, the charge indicator shows that charge is in progress.

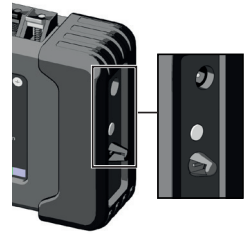
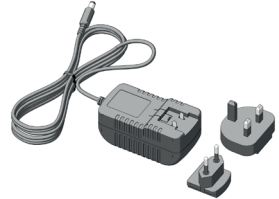

### 3.2 Connection

The spring-loaded connectors to which the loop cables must be connected are located on the upper part of the equipment.

The first device in the loop must be connected to the right connectors, while the return cables must be connected to the left connectors.

There is also a connection point for the earthing cable on the device.

The positions of the cables on the terminal board are indicated in the upper part of the touch screen panel, in the HOME screen.

The following is an example of connection.

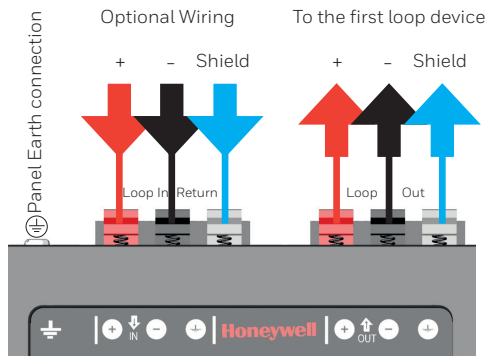



The POL-200-TS unit reports any short-circuit fault conditions in the loop (showing a lightning icon ⚡), and reverse polarity wiring (a diode icon ➡). It can also identify within seconds the total number of devices connected to the loop. This icons will appear in the lower right corner.

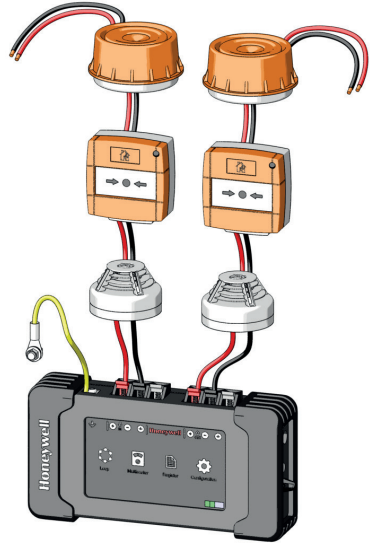

**Confirm that the loop wiring is correct:**

- The characteristics considered are for wiring in closed loop mode (from output and back to input)
- The maximum resistance allowed from the OUTPUT end of the fire detection panel (or from POL-200-TS) to the INPUT in the fire detection panel is 40 ohms.

Refer to the installation recommendations enclosed to the fire detection control panel to connect the monitored loop to POL-200-TS. The fire panel installation manual includes the different type of cables that should be used.

The following table shows the approximate resistive values for two recommended loop cable types:

	500mts	750mts	1000mts	1250mts	1500mts	2000mts	2500mts	3000mts
Cable 1.5mm <sup>2</sup>	7	10	13	17	20	27	33	40
Cable 2.5mm <sup>2</sup>	4	6	8	10	12	16	20	24

Shielded/screen cables should only be connected to ground, GND, on one point inside the fire panel. The POL-200-TS allows the user to confirm that the shield is continuous, so it should be approximately twice (2x) and three (3x) times the resistance of the negative conductor. So, in case that the negative conductor has a:

- Capacitance between loop conductors + and – is below 0.5mF or 500nF
- Impedance between positive and cable shield (Infinite).

### 3.3 Main menu

When the device is turned on, the HOME screen appears. From this screen it is possible to access all the device functions described in the following paragraphs.

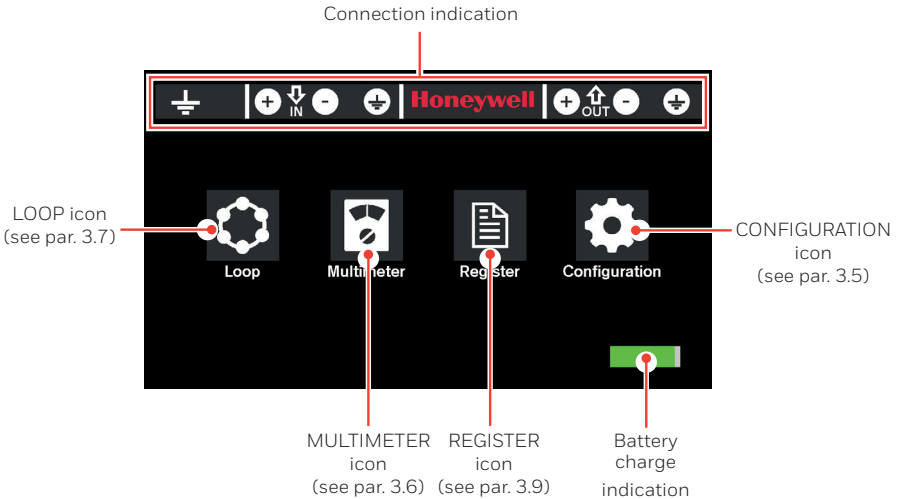

### 3.4 Set language

To change the language, from the main menu press the CONFIGURATION icon and then the LANGUAGE icon.

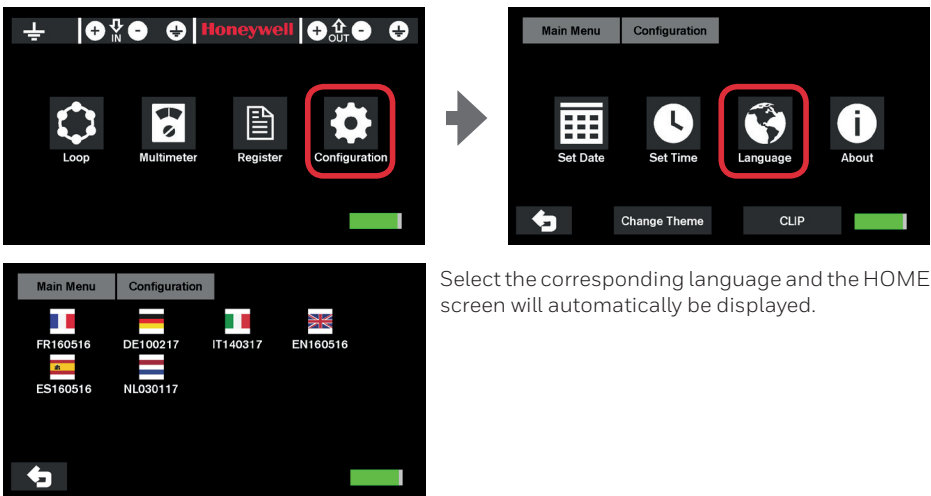

Select the corresponding language and the HOME screen will automatically be displayed.

## 3.5 Configuration

In the configuration section, the user can change the device date and time as well as the language.

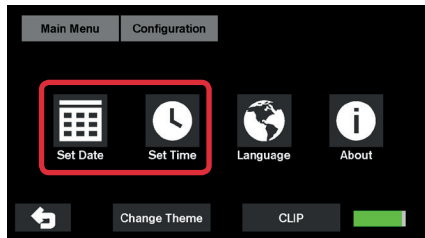
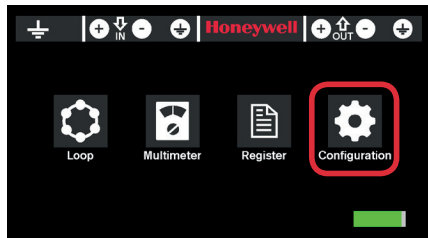

Through the appropriate keypads enter the current date and time, then confirm by pressing OK.

Format DATE dd:mm:yy

Format TIME hh:mm:ss

The lower  icon allows selecting the two types of CLIP protocols available used by Notifier ID50 / 60 and ID3000, HBS XLS80 and Morley DXc or Advanced used by Notifier Pearl and AM8200 (See par. LOOP 3.7).

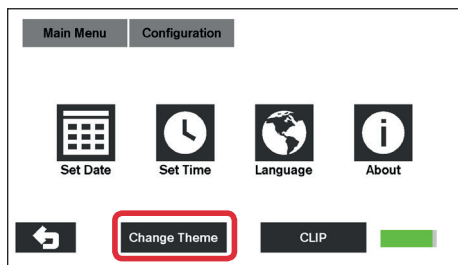

The “**Change Theme**” button allows changing the screen background from white to black and vice versa.

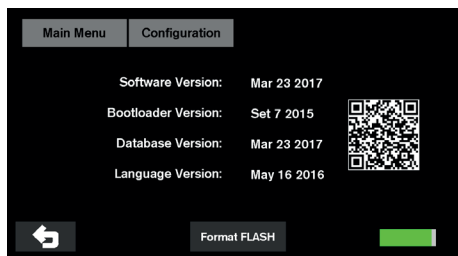

The “**About**” icon indicates the software version of POL-200-TS.

 The “**Flash Format**” option should only be used if indicated by Honeywell technical department.

The “**QR**” icon allows accessing with a Smartphone the latest online version of the manual from this web link

<https://notifier.es/index.php/documentos/manuales/category/pol-200-ts>

### 3.6 Multimeter

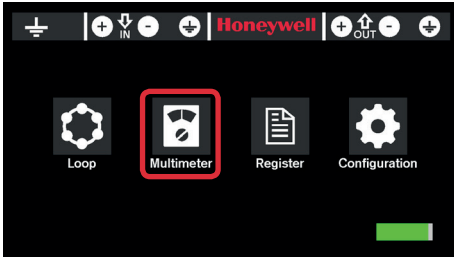

The Multimeter function can be accessed from the main screen. The multimeter allows the installer to check that the line impedance described in the previous section is correct.

**i** After the connection check that POL-200-TS has the correct load level. Please note that batteries with an insufficient charge level can falsify the measurements.

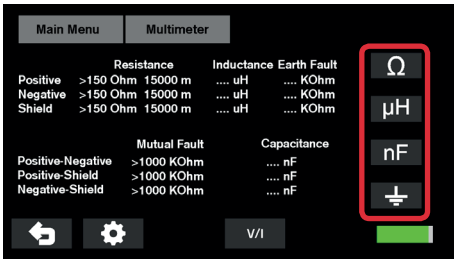

Press  $\Omega$  to display the resistance values,  $\mu\text{H}$  for the inductance values, nF for the capacity values,  $\text{⏏}$  for the ground values.

Please see Fire panel specification requirements for recommended values.

Then check for each voltage range (0V, 5V and 24V) the voltages and consumption shown by pressing key **V/I**.

Check for possible drifts, short circuits, faulty elements, connections or inadequate system devices or external to the system depending on the values obtained.

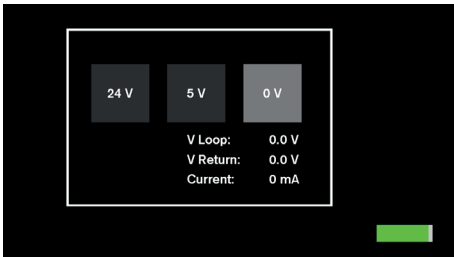

The 24V reading will provide a reference voltage drop in the loop, a V return below 17Vdc indicates that the resistance is too high in the loop.

Below the 5V reading there should not be consumption. Check the possible existence of junctions or inductions.

By pressing **⚙** the resistance value of connectors (Ohm/Km) can be set.

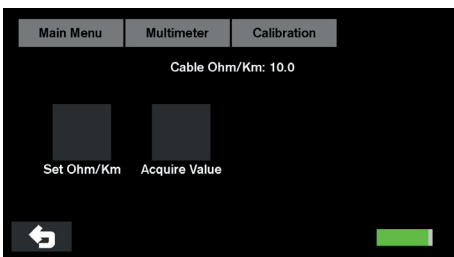

“Set Ohm/Km” allows the direct setting of the values through the numeric keypad. Ohm/Km may be changed depending on the cable used.

“Acquire Value” allows measuring the resistance value after inserting the cable length.

### 3.7 Loop

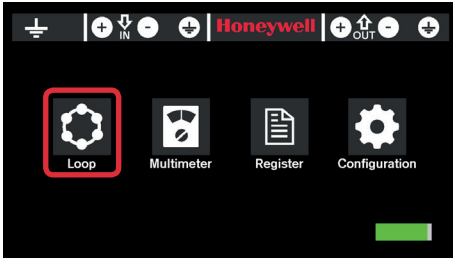



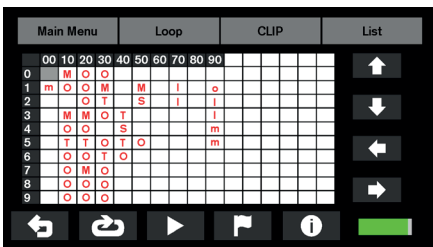
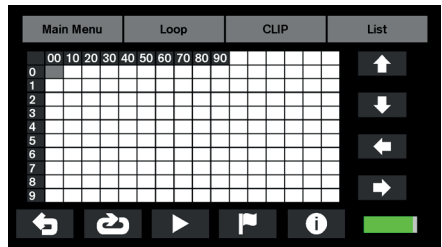
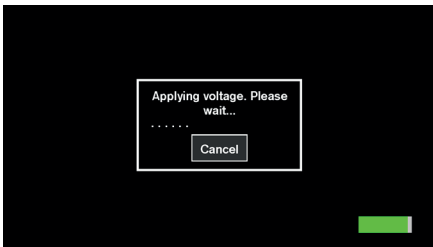
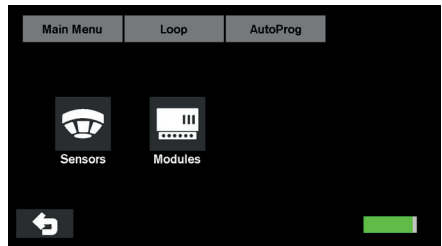
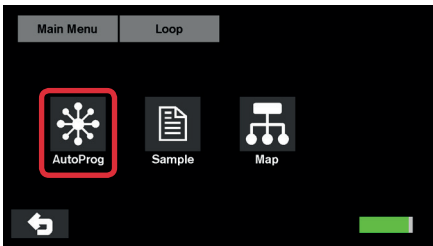

The tool recognizes the sensors and modules on the loop before powering the fire alarm control panel (FACP). The POL-200-TS unit is compatible with CLIP (Classic Loop Interface Protocol) with 99 sensors and 99 modules and the new Advanced or Opal protocol with up to 159 sensors and 159 modules.

In the **auto-programming** menu, the tool will identify the number of sensors or modules that are connected in the loop according to their type:



By pressing  the system carries out a reading cycle that scans all the positions to find the devices connected (sensors or modules according to what has been selected in the previous screen).

The reading cycle can be continuous if  is selected. To stop the continuous reading cycle press , then select  and press  to carry out only one cycle.

According to the protocol used (refer to par. 3.5), the system shows the position and the type of device connected.

**CLIP PROTOCOL**

- “O” Optical Sensor
- “H” or “T” Heat/Thermal sensor
- “I” ionization sensor
- “M” Multi-Sensor. Optical/ thermal
- “P” Pinnacle Laser
- “L” VIEW Laser
- “S” Smart Multi-criteria

Section of Modules - Symbols of identification by type:

- “I” or “E” Input Modules including Manual Call Points
- “O” or “S” Output modules
- “R” Output modules without End-of-Line (EOL) by default Relays
- “Z” Zone modules for conventional detectors

**ADVANCED PROTOCOL**

For advanced protocol loops, POL-200-TS also identifies the following elements:

- “S” SMART 4
- “B” Beam detectors
- “P” Indoor Manual Call Point
- “M” FAAST Aspiration unit

To select between CLIP and ADVANCED Protocol please access the configuration screen and select one of the two protocols available from the button line.

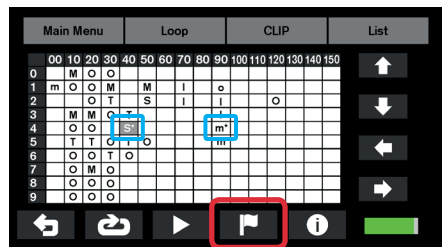
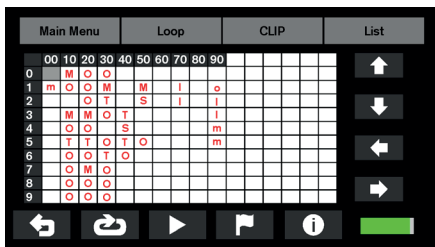

**Lower Case or Capital Letter:** if a lower case letter appears in the reading cycle, please confirm in the configuration that the correct protocol is selected among these different options “Notifier”, “Morley”, “System Sensor” or “Honeywell HBS”.

In case in one address a device changes the type ID or in case of a change from lower case to capital letter, please check the wiring in this device as its answer is not correct. This can be caused by a defective device or noise due to interferences.

A “?” character in the ID type field can indicate a problem in the device or problems in the wiring line.

A “-” character in ID type may indicate a duplicate address.

For each sampling POL-200-TS identifies the changes that have occurred since the previous sampling, and the type of ID identifying each address will appear in red or black. The red colour indicates that a change has occurred.

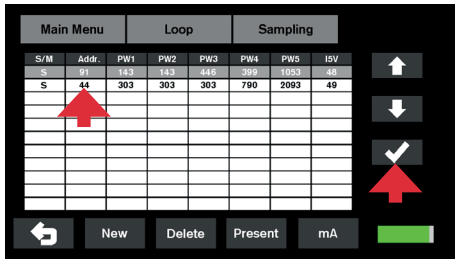

To get more details about each element, select them by clicking directly on them or using the cursors and mark them by pressing the button .

If you hold down this button, you will get the details of the selected item in the sampling table.

 The PWs value is for Honeywell technical team references. PW1 should be around 150 +/- 10% in Honeywell and Morley while around 300 +/- 10% for Notifier/ System Sensor. Other values outside these range should be reported to Honeywell technical support for advice.

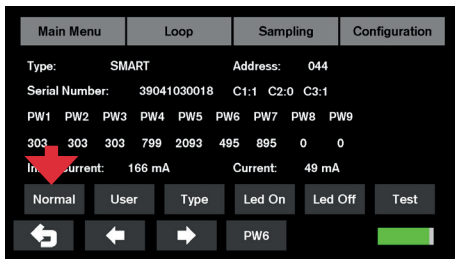

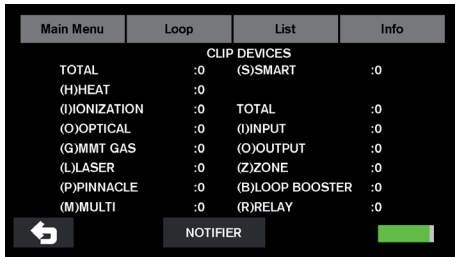

Select one of the items in the sampling table with the help of the arrows (arrows in the right margin of the screen) or by clicking on the screen. Press the button  to access the advanced user information screen.

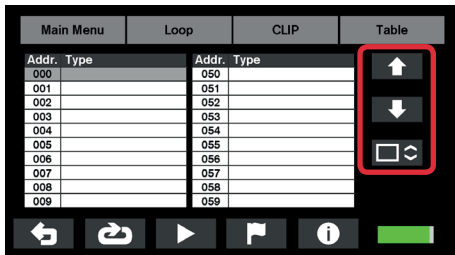

From the self-programming menu by pressing the **List** button, the user can display a summary of the elements installed.



By clicking on the icon  you will have access to a more detailed list of loop devices. Use the scroll keys located on the right side of the screen to move of 1 in 1 or in blocks of 10.

Press  and  to move selection of a single line.

Enable  to scroll one full page at a time.



## 3.8 Sample

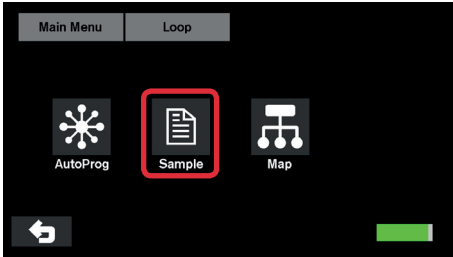

The **Sample** option allows the user to select a list of devices that will be monitored continuously with detailed information in CLIP mode for address below 99.

## 3.9 Map

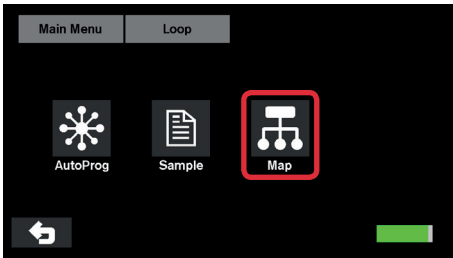



By pressing “**Map**” it is possible to visually check the loop wiring map. Follow the instructions below:

If the installer has correctly wired the isolators using the +IN, +OUT terminals in the B501AP or in the module terminals, POL-200-TS will activate the isolator and a graph is displayed.

POL-200-TS provides a device map for any of the protocols, CLIP or Advanced. Given the characteristics of each protocol, the position of each device may change according to the information obtained.

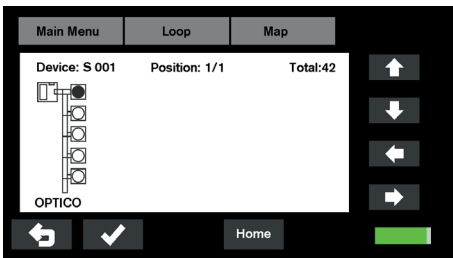
Remember that in CLIP protocol and multi-module devices, each input or output occupies one address in the loop. For Advanced protocol only the main address will be visible.



-  The ISO terminals must be properly wired and the devices must support Advanced Protocol to obtain the right mapping.
-  Devices like View FSL-751 or Pinnacle only answer in CLIP protocol, so do not include an isolator to be activated from POL-200-TS.

## 3.10 Event Recording

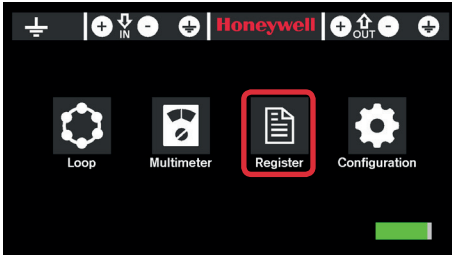

The values selected from the **self-programming** screen can be recorded in a text file.

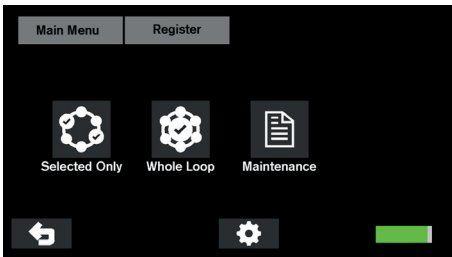

When you access the recording screen, 3 recording options will be displayed:

- Only selected items
- Full loop
- Maintenance

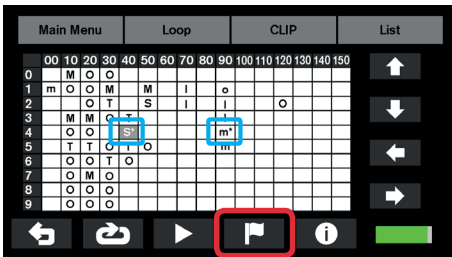

The first option requires previously performing a self-programming of the loop and marking the elements to record.

To do this proceed as previously described, select the elements using the cursors (arrows in the right margin of the screen) and press the button .

Once the devices are selected and the **“only selected items”** register option is selected, POL-200-TS will display the following screen:

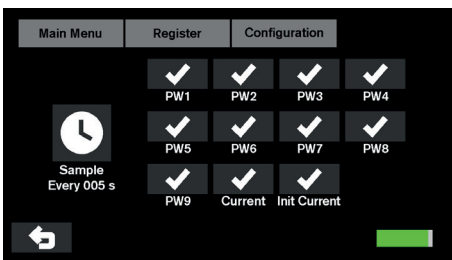

Record through the configuration option only the necessary information, consult Honeywell's technical department or, if in doubt, select all the options.

While logging is done, click on the backspace icon to finish capturing data in the log file.

We recommend using a short sampling time for a short period, even a single default reading for stable loops. Extending the sample time will result in a larger file size that will reduce the available space of the machine for future reports.

The maintenance option will create a text file with “.MNT” extension that can be edited with “notepad” or Word for later editing.

The USB connector allows the installer to download the loop device maintenance file or to update the firmware when a new version is available.

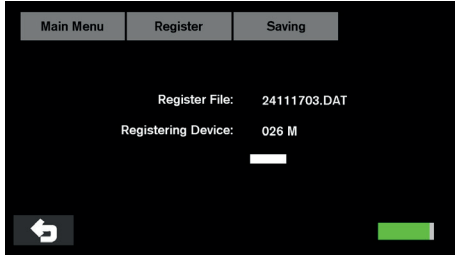

**NOTE.** We recommend removing old maintenance and log files connecting POL-200 TS to the PC periodically to create new records.

S/M	Type	Manuf	PW1	PW2	PW3	PW4	PW5	PW6	PW7	PW8	PW9	I (mA)	L_Init (mA)
S	OPTICAL	NOT	0295	0292	0292	0795	0894	2094	0000	0000	0000	050	098
S	OPTICAL	NOT	0295	0292	0293	0794	0894	2094	0000	0000	0000	050	099
S	OPTICAL	NOT	0294	0292	0293	0795	0894	2094	0000	0000	0000	049	099
S	OPTICAL	NOT	0294	0292	0293	0794	0895	2094	0000	0000	0000	049	099
S	OPTICAL	NOT	0294	0292	0293	0795	0894	2094	0000	0000	0000	049	099
S	OPTICAL	NOT	0294	0292	0293	0794	0894	2094	0000	0000	0000	049	099
S	OPTICAL	NOT	0294	0292	0293	0794	0894	2094	0000	0000	0000	049	098

## 4. Battery replacement

 The battery life lasts maximum 3 years; after this period and if charge duration shortens, replace batteries.

### Use 6 AA type, 220 mAh rechargeable batteries

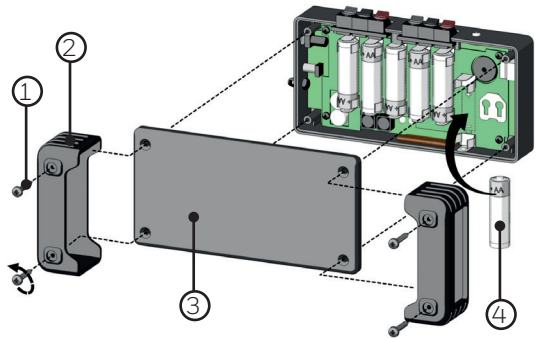

 Danger of explosion in case of inappropriate battery replacement! Batteries must be disposed of according to the laws in force.

To replace batteries, do as follows:  
by means of a Phillips screwdriver, unscrew the four screws "1", extract the lateral rubber protections "2" and remove cover "3".  
Replace batteries "4", then mount the components again.



 Before using the device, perform a complete recharge cycle by using the supplied charger.

## 5. Troubleshooting

MESSAGE/ PROBLEM	CAUSE/SOLUTION
	If this symbol appears in the right low corner, a short-circuit between loop positive and negative is monitored. Please break the loop into sections to identify where the short-circuit is.
	This symbol indicates an inverse wiring fault. Please break the loop into sections to identify where the loop negative is incorrectly connected to the loop positive, or vice versa.
<b>"h"... lower case:</b>	If in the auto-learn ALL the devices in the loop appear with a lower case letter, please check the protocol selected in the Configuration. It may be that the selected loop protocol, i.e. Morley, System Sensor or Honeywell HBS; does not match the loop devices.
<b>The screen flashes or it switches off:</b>	Check if the battery loading level is adequate.
	The batteries may be damaged, replace them.
<b>The device tags disappear or the question character appears:</b>	Check that the loop conditions meet Honeywell requirements.
	Try replacing the device and check again.
	Check for possible noise on the line.
	Record the information and check the possibility of cycles that are not carried out correctly, of excessive current, etc.
<b>No devices appear:</b>	Check that you have not selected Advanced protocol instead of CLIP protocol
	Check that the loop is connected to the input, "IN" of the POL-200-TS device.
<b>There is no data recorded in my *.MNA, *.MNC and / or *.DAT files:</b>	Remove or delete old files, they take up the available memory space.

## Notes

---

---

---

---

---

---

---

---

---

---

---

---

---

---

---

---

---

---

---

---

---

---

---

---

## Notes

---

---

---

---

---

---

---

---

---

---

---

---

---

---

---

---

---

---

---

---

---

---

---

---

---

---

**Honeywell**

C/Pau Vila 15-19  
08911 Badalona  
Barcelona, Spain  
Tel.: 931 334 760

[www.honeywelllifesafety.es](http://www.honeywelllifesafety.es)

POL-200-TS Diagnostic tool  
Ref doc.: MN-HON-POL-200-TS\_EN v.03  
12-17  
© 2017 Honeywell International Inc.

**Honeywell**